



Thermographic Handheld Camera

User Manual

© 2020 Hangzhou Hikvision Digital Technology Co., Ltd. All rights reserved.

About this Manual

The Manual includes instructions for using and managing the Product. Pictures, charts, images and all other information hereinafter are for description and explanation only. The information contained in the Manual is subject to change, without notice, due to firmware updates or other reasons. Please find the latest version of this Manual at the Hikvision website (<http://www.hikvision.com/>).

Please use this Manual with the guidance and assistance of professionals trained in supporting the Product.

Trademarks Acknowledgement

- **HIKVISION** and other Hikvision's trademarks and logos are the properties of Hikvision in various jurisdictions.
- Other trademarks and logos mentioned are the properties of their respective owners.

LEGAL DISCLAIMER

TO THE MAXIMUM EXTENT PERMITTED BY APPLICABLE LAW, THIS MANUAL AND THE PRODUCT DESCRIBED, WITH ITS HARDWARE, SOFTWARE AND FIRMWARE, ARE PROVIDED "AS IS" AND "WITH ALL FAULTS AND ERRORS". HIKVISION MAKES NO WARRANTIES, EXPRESS OR IMPLIED, INCLUDING WITHOUT LIMITATION, MERCHANTABILITY, SATISFACTORY QUALITY, OR FITNESS FOR A PARTICULAR PURPOSE. THE USE OF THE PRODUCT BY YOU IS AT YOUR OWN RISK. IN NO EVENT WILL HIKVISION BE LIABLE TO YOU FOR ANY SPECIAL, CONSEQUENTIAL, INCIDENTAL, OR INDIRECT DAMAGES, INCLUDING, AMONG OTHERS, DAMAGES FOR LOSS OF BUSINESS PROFITS, BUSINESS INTERRUPTION, OR LOSS OF DATA, CORRUPTION OF SYSTEMS, OR LOSS OF DOCUMENTATION, WHETHER BASED ON BREACH OF CONTRACT, TORT (INCLUDING NEGLIGENCE), PRODUCT LIABILITY, OR OTHERWISE, IN CONNECTION WITH THE USE OF THE PRODUCT, EVEN IF HIKVISION HAS BEEN ADVISED OF THE POSSIBILITY OF SUCH DAMAGES OR LOSS.

YOU ACKNOWLEDGE THAT THE NATURE OF INTERNET PROVIDES FOR INHERENT SECURITY RISKS, AND HIKVISION SHALL NOT TAKE ANY RESPONSIBILITIES FOR ABNORMAL OPERATION, PRIVACY LEAKAGE OR OTHER DAMAGES RESULTING FROM CYBER-ATTACK, HACKER ATTACK, VIRUS INSPECTION, OR OTHER INTERNET SECURITY RISKS; HOWEVER, HIKVISION WILL PROVIDE TIMELY TECHNICAL SUPPORT IF REQUIRED.

YOU AGREE TO USE THIS PRODUCT IN COMPLIANCE WITH ALL APPLICABLE LAWS, AND YOU ARE SOLELY RESPONSIBLE FOR ENSURING THAT YOUR USE CONFORMS TO THE APPLICABLE LAW. ESPECIALLY, YOU ARE RESPONSIBLE, FOR USING THIS PRODUCT IN A MANNER THAT DOES NOT INFRINGE ON THE RIGHTS OF THIRD PARTIES, INCLUDING WITHOUT LIMITATION, RIGHTS OF PUBLICITY, INTELLECTUAL PROPERTY RIGHTS, OR DATA PROTECTION AND OTHER PRIVACY RIGHTS. YOU SHALL NOT USE THIS PRODUCT FOR ANY PROHIBITED END-USES, INCLUDING THE DEVELOPMENT OR PRODUCTION OF WEAPONS OF MASS DESTRUCTION, THE DEVELOPMENT OR PRODUCTION OF CHEMICAL OR BIOLOGICAL WEAPONS, ANY ACTIVITIES IN THE CONTEXT RELATED TO ANY NUCLEAR EXPLOSIVE OR UNSAFE NUCLEAR FUEL-CYCLE, OR IN SUPPORT OF HUMAN RIGHTS ABUSES.

IN THE EVENT OF ANY CONFLICTS BETWEEN THIS MANUAL AND THE APPLICABLE LAW, THE LATER PREVAILS.

Regulatory Information

FCC Information

Please take attention that changes or modification not expressly approved by the party responsible for compliance could void the user's authority to operate the equipment.

FCC compliance: This equipment has been tested and found to comply with the limits for a Class B digital device, pursuant to part 15 of the FCC Rules. These limits are designed to provide reasonable protection against harmful interference in a residential installation. This equipment generates, uses and can radiate radio frequency energy and, if not installed and used in accordance with the instructions, may cause harmful interference to radio communications. However, there is no guarantee that interference will not occur in a particular installation. If this equipment does cause harmful interference to radio or television reception, which can be determined by turning the equipment off and on, the user is encouraged to try to correct the interference by one or more of the following measures:

- Reorient or relocate the receiving antenna.
- Increase the separation between the equipment and receiver.
- Connect the equipment into an outlet on a circuit different from that to which the receiver is connected.
- Consult the dealer or an experienced radio/TV technician for help.

This equipment should be installed and operated with a minimum distance 20cm between the radiator and your body.

FCC Conditions

This device complies with part 15 of the FCC Rules. Operation is subject to the following two conditions:

1. This device may not cause harmful interference.
2. This device must accept any interference received, including interference that may cause undesired operation

EU Conformity Statement



This product and - if applicable - the supplied accessories too are marked with "CE" and comply therefore with the applicable harmonized European standards listed under the EMC Directive 2014/30/EU, the RoHS Directive

2011/65/EU.



2012/19/EU (WEEE directive): Products marked with this symbol cannot be disposed of as unsorted municipal waste in the European Union. For proper recycling, return this product to your local supplier upon the purchase of equivalent new equipment, or dispose of it at designated collection points. For more information see: www.recyclethis.info.



2006/66/EC (battery directive): This product contains a battery that cannot be disposed of as unsorted municipal waste in the European Union. See the product documentation for specific battery information. The battery is marked with this symbol, which may include lettering to indicate cadmium (Cd), lead (Pb), or mercury (Hg). For proper recycling, return the battery to your supplier or to a designated collection point. For more information see: www.recyclethis.info.

Industry Canada ICES-003 Compliance

This device meets the CAN ICES-3 (B)/NMB-3(B) standards requirements.

This device complies with Industry Canada licence-exempt RSS standard(s). Operation is subject to the following two conditions:

- (1) this device may not cause interference, and
- (2) this device must accept any interference, including interference that may cause undesired operation of the device.

User Manual of Thermographic Handheld Camera

Le présent appareil est conforme aux CNR d'Industrie Canada applicables aux appareils radioexempts de licence. L'exploitation est autorisée aux deux conditions suivantes:

- (1) l'appareil ne doit pas produire de brouillage, et
- (2) l'utilisateur de l'appareil doit accepter tout brouillage radioélectrique subi, même si le brouillage est susceptible d'en compromettre le fonctionnement.

Under Industry Canada regulations, this radio transmitter may only operate using an antenna of a type and maximum (or lesser) gain approved for the transmitter by Industry Canada. To reduce potential radio interference to other users, the antenna type and its gain should be so chosen that the equivalent isotropically radiated power (e.i.r.p.) is not more than that necessary for successful communication.



Conformément à la réglementation d'Industrie Canada, le présent émetteur radio peut fonctionner avec une antenne d'un type et d'un gain maximal (ou inférieur) approuvé pour l'émetteur par Industrie Canada. Dans le but de réduire les risques de brouillage radioélectrique à l'intention des autres utilisateurs, il faut choisir le type d'antenne et son gain de sorte que la puissance isotrope rayonnée équivalente (p.i.r.e.) ne dépasse pas l'intensité nécessaire à l'établissement d'une communication satisfaisante.

This equipment should be installed and operated with a minimum distance 20cm between the radiator and your body.

Cet équipement doit être installé et utilisé à une distance minimale de 20 cm entre le radiateur et votre corps.

Symbol Convention

The symbols that may be found in this document are defined as follows.

Symbol	Description
 NOTE	Provides additional information to emphasize or supplement important points of the main text.
 WARNING	Indicates a potentially hazardous situation, which if not avoided, could result in equipment damage, data loss, performance degradation, or unexpected results.
 DANGER	Indicates a hazard with a high level of risk, which if not avoided, will result in death or serious injury.

Safety Instructions

These instructions are intended to ensure that user can use the product correctly to avoid danger or property loss.

Laws and Regulations

- Use of the product must be in strict compliance with the local electrical safety regulations.

Transportation and Storage

- Keep the device in original or similar packaging while transporting it.
- Keep all wrappers after unpacking them for future use. In case of any failure occurred, you need to return the device to the factory with the original wrapper. Transportation without the original wrapper may result in damage on the device and the company shall not take any responsibilities.
- Do not drop the product or subject it to physical shock. Keep the device away from magnetic interference.

Power Supply

- Please use the power adapter, which is provided by normal company. Input voltage should meet the Limited Power Source (5 VDC, 2A) according to the IEC61010-1 standard. Please refer to technical specifications for detailed information.
- Make sure the plug is properly connected to the power socket.
- DO NOT connect multiple devices to one power adapter, to avoid over-heating or fire hazards caused by overload.

Battery

- Improper use or replacement of the battery may result in explosion hazard. Replace with the same or equivalent type only. Dispose of used batteries in conformance with the instructions provided by the battery manufacturer.
- Do not charge other battery types with the supplied charger. Confirm there is no flammable material within 2 m of the charger during charging.
- For long-term storage of the battery, make sure it is fully charged every half year to ensure the battery quality. Otherwise, damage may occur.
- DO NOT place the battery near heating or fire source. Avoid direct sunlight.
- DO NOT swallow the battery to avoid chemical burns.
- DO NOT place the battery in the reach of children.

Maintenance

- Clean the lens with soft and dry cloth or wiping paper to avoid scratching it.
- Wipe the device gently with a clean cloth and a small quantity of ethanol, if

necessary.

- If the product does not work properly, please contact your dealer or the nearest service center. We shall not assume any responsibility for problems caused by unauthorized repair or maintenance.
- A few device components (e.g., electrolytic capacitor) require regular replacement. The average lifespan varies, so periodic checking is recommended. Contact your dealer for details.

Using Environment

- DO NOT expose the device to extremely hot, cold, dusty, corrosive, saline-alkali, or damp environments. Make sure the running environment meets the requirement of the device. The operating temperature shall be -10 °C to 50 °C (14 °F to 122 °F), and the operating humidity shall be 90% or less.
- This device can only be safely used in the region below 2000 meters above the sea level.
- Avoid equipment installation on vibratory surface or places subject to shock (neglect may cause equipment damage).
- Do not aim the lens at the sun or any other bright light.

Emergency

- If smoke, odor, or noise arises from the device, immediately turn off the power, unplug the power cable, and contact the service center.

Manufacture Address

No.555 Qianmo Road, Binjiang District, Hangzhou 310052, China
Hangzhou Hikvision Digital Technology Co.,Ltd

User Manual of Electrical Version

Scan the QR code to view the user manual on your mobile phone. Note that mobile data charges may apply if Wi-Fi is unavailable.



Table of Contents

1	Overview	1
1.1	Device Description	1
1.2	Main Functions	1
1.3	Appearance	3
2	Preparation	4
2.1	Charge Device	4
2.1.1	Charge Device via Cable Interface	4
2.1.2	(Optional) Charge Device via Charging Base	4
2.2	Power On/Off	7
2.2.1	Set Auto Power-off Duration	7
2.3	Operation Methods	7
2.4	Menu Description	8
3	Display Settings	9
3.1	Focus Lens	9
3.2	Set Screen Brightness	10
3.3	Set Display Mode	10
3.4	Set Palettes	11
3.5	Adjust Digital Zoom	12
3.6	Display Device Status	12
3.7	Display Date and Time	13
4	Temperature Measurement	13
4.1	Set Thermography Parameters	13
4.1.1	Set Units	15
4.2	Set Temperature Difference/Range	15
4.3	Set Thermography Rule	16
4.3.1	Set Point Rule	17
4.3.2	Set Line Rule	17
4.3.3	Set Frame Rule	18
4.3.4	Delete Rules	19
4.4	Set Black Body Temperature Calibration	19
4.4.1	Auto Calibration	19
4.4.2	Manual Calibration	20
4.5	Set Temperature Alarm	21
5	Picture and Video	22
5.1	Capture Picture	22
5.2	Record Video	24
5.3	View Recorded Files	24
5.4	Export Files	25
6	Connect Bluetooth	26

7	Hik-Thermal APP Connection	26
7.1	Connect via Wi-Fi	26
7.2	Connect via Hot Spot.....	27
8	Maintenance.....	28
8.1	View Device Information	28
8.2	Upgrade Device	28
8.3	Restore Device.....	29
9	Appendix.....	29
9.1	Common Material Emissivity Reference	29
9.2	Device Command.....	30
9.3	Device Communication Matrix	30
9.4	Frequently Asked Questions (FAQ).....	31

1 Overview

1.1 Device Description

The thermographic handheld camera is a device with both optical images and thermal images. It can realize thermography, video recording, snapshot capturing, alarm. It can connect to Wi-Fi, hotspot, and Bluetooth. The built-in high-sensitivity IR detector and high-performance sensor detect the variation of temperature and measure the real-time temperature.

The picture-in-picture technique of the thermography camera and the fusion of optical view and thermal view enhances the details of the images display. It supports multiple palettes and alarm types. When the detected temperature in the scene does not match with the alarm rules, the device alarms by color of the palette mode automatically. It helps to find the risky part and lower your property loss. The device supports Wi-Fi connection, live view, recording, and capturing, etc.

The device is easy to use, and adopts ergonomic design. It is widely applied to substations, electricity prevention detection of companies, and reconnaissance survey of construction field.

1.2 Main Functions

Thermography

Device detects the real-time temperature, and displays it on the screen.

Storage

Device is equipped with memory module to store videos, snapshots, and important data.

Fusion

Device can display fusion of thermal view and optical view.

Palette and Alarm

Device supports multiple palettes, and you can set the palette mode according to the alarm function.

Client Software Connection

You can connect the device with Hik-Thermal APP via Wi-Fi or hot spot to view live view, capture, and recording, etc. on your phone.

You can connect the device with iVMS-4800 to analyze the thermography pictures captured by devices.

Bluetooth

Device can be connected to headset via Bluetooth, and you can hear the sound in the recording or capture.

Digital Zoom

Device supports 1×, 2×, and 4× digital zoom.

1.3 Appearance

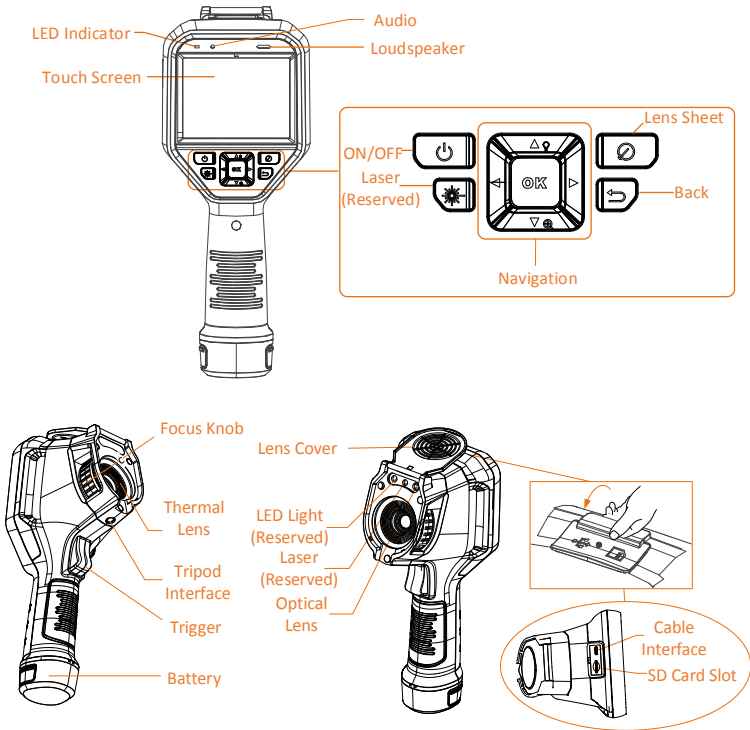

Component	Function
Laser Button	Reserved.
Navigation Button	Menu Button:
	<ul style="list-style-type: none"> - Press ∇, Δ, \triangleright, and \triangleleft to select parameters. - Press OK to confirm.
Lens Sheet Button	Non-Menu Button:
	<ul style="list-style-type: none"> - Reserved. - Hold ∇ to realize digital zoom.
Back Button	Exits the menu or return to previous menu.
Focus Knob	Adjusts lens focal length. Refer to <i>3.1 Focus Lens</i> .

Component	Function
Trigger	Pulls the trigger to record videos or capture snapshots.
Cable Interface	Connects the device to your PC via cable to export files.

2 Preparation

2.1 Charge Device

2.1.1 Charge Device via Cable Interface

Before you start:

Please make sure the battery is installed before charging.

Steps:

1. Open the top cover of the device.
2. Connect the interface and the power adaptor with Type-C cable.

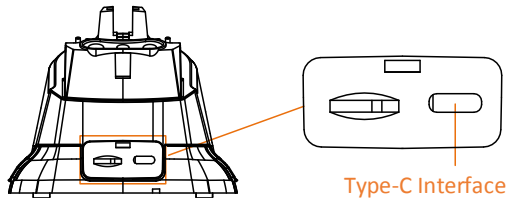

2.1.2 (Optional) Charge Device via Charging Base

Before you start:

You need to purchase charging base.

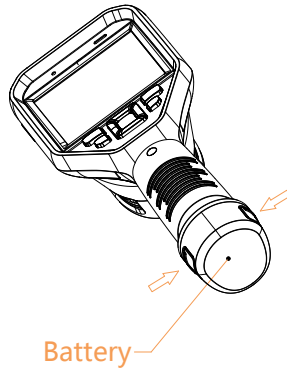

Steps:

1. Hold the device, and press both battery lock catches of the device. See figure below.

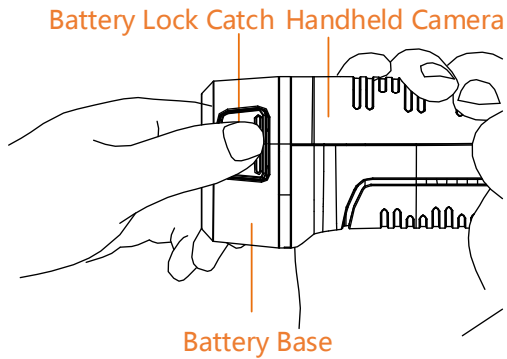

2. Hold the lock catches, and draw the battery base to take out the battery. See figure below.

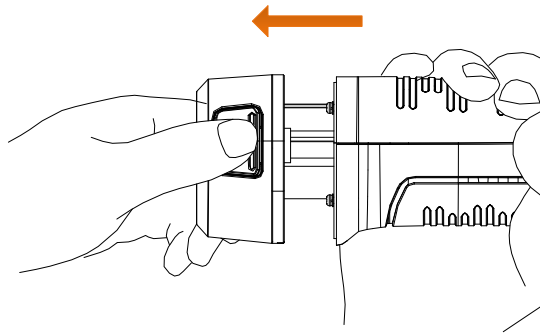

3. Insert the battery into the charging base. See figure below. You can see the charging status via the pilot lamp on the charging base.

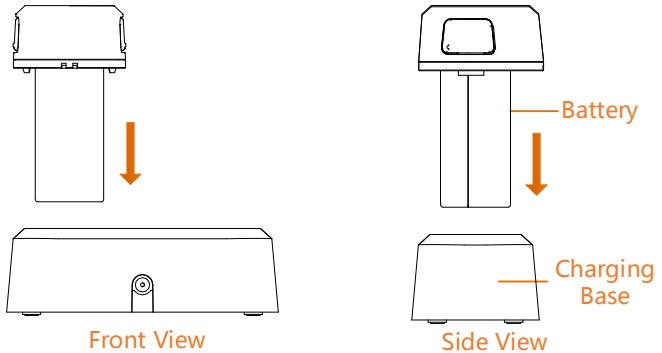

4. When the battery is fully charged, draw the battery from the charging base.
5. Align the ribbed piece on battery with the notch of the device, and insert battery into the device. See figure below.

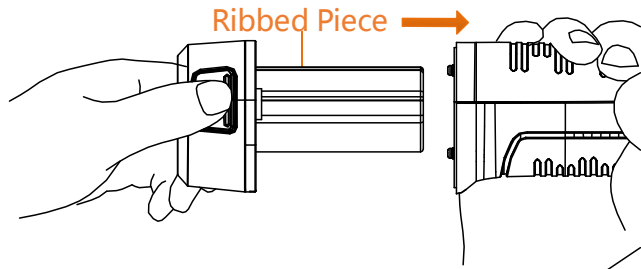

2.2 Power On/Off

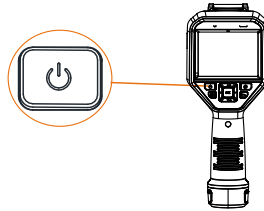

Power On

Remove the lens cover, and hold the  button for over three seconds to turn on the device. You can observe the target when the interface of the device is stable.

NOTE

It may take at least 30 s until the device is ready for using when you power on it.

Power Off

When the monocular is turned on, hold the  button for three seconds to power off the device.

2.2.1 Set Auto Power-off Duration

Go to **Local Settings**  > **Device Settings** > **Auto Power-off Duration Settings** to set the automatic shutdown time for device as required.

2.3 Operation Methods

The device supports both touchscreen control and button control.

Touchscreen control

Tap on the screen to configure the device.

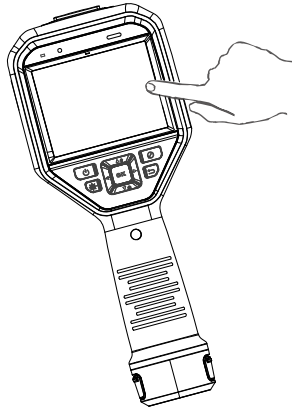

Button control

Press the navigation buttons to configure the device.

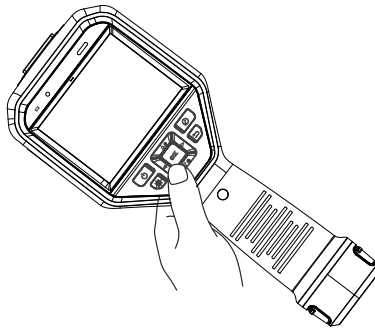

- Press the Δ , ∇ , \triangleright , and \triangleleft to move the cursor up/down/right/left.
- Press **OK** to confirm.

2.4 Menu Description

In the observation interface, tap the screen or press **OK** to show the menu bar. See figure below.

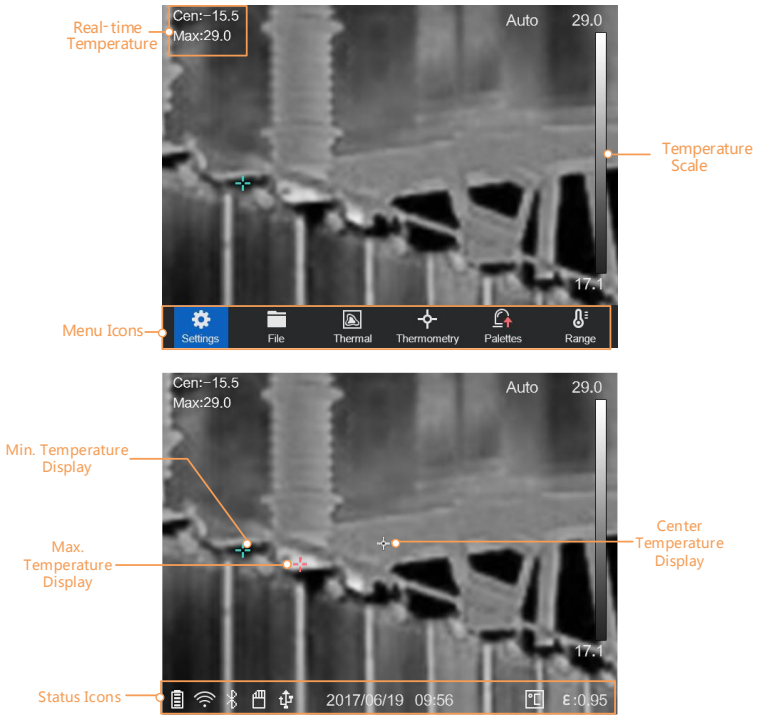

3 Display Settings

3.1 Focus Lens

Before you start:

Adjust the lens focal length properly before any other configuration, or it may affect the image display and temperature accuracy.

Steps:

1. Power on the device.
2. Aim the device lens to the appropriate scene.

3. Adjust the focus knob clockwise or anticlockwise. See figure below.

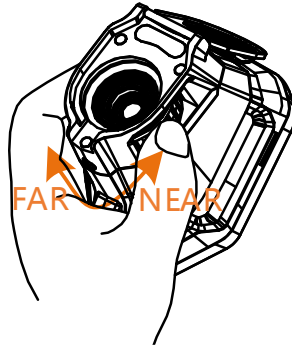

WARNING

DO NOT touch the lens to avoid affecting the display effect.

3.2 Set Screen Brightness

Go to **Local Settings** (⚙️) > **Device Settings** > **Display Brightness** to set the screen brightness. It can be set as **Low**, **Medium**, or **High**.

3.3 Set Display Mode

Purpose:



You can set the thermal/optical view of the device. **Thermal**, **Fusion**, **PIP**, and **Optical** are selectable.

Steps:

1. Select the **Thermal/Optical Settings** (📷) from the main menu.



2. Tap the icons to select a view mode.

Icon	Mode	Description
	Thermal	In thermal mode, the device displays the thermal view.
	Fusion	In fusion mode, the device displays the combined view of thermal channel and optical channel. You can tap  in live view and press > and < to adjust fusion level. Or you can adjust it in Settings > Image Settings > Fusion Level .
	PIP	In PIP (Picture in Picture) mode, the device displays thermal view inside the optical view. You can tap  in live view and press > and < to adjust PIP proportion. Or you can adjust it in Settings > Image Settings > PIP proportion .
	Optical	In optical mode, the device displays the optical view.

3. Press  to exit.

3.4 Set Palettes

Purpose:

The palettes allow you to select the desired colors.

Steps:

1. Select  from the main menu.

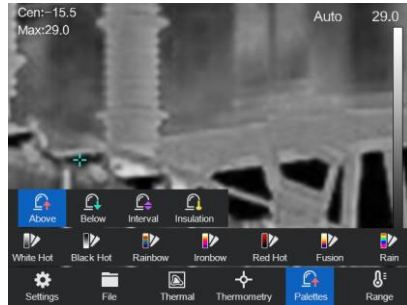

2. Tap the icons to select a palette type.

Icon	Palette	Description
	White Hot	The hot part is light-colored in view.
	Black Hot	The hot part is black-colored in view.
	Rainbow	The target displays multiple colors. It's suitable for scene without obvious temperature difference.
	Ironbow	The target is colored as heated iron.
	Red Hot	The hot part is red-colored in view.
	Fusion	The hot part is yellow-colored and the cold part is purple-colored in view.
	Rain	The hot part in the image is colored, and the else is blue.

3. Press to exit the setting interface.

3.5 Adjust Digital Zoom

In the live view interface, press to adjust the digital zoom to 1×, 2×, or 4×. Then you can view the target or scene in larger size.

3.6 Display Device Status

Go to **Local Settings** > **Image Settings** > **Display Settings** to enable the status icons display. Then you can view the device status in live view interface.

3.7 Display Date and Time

Go to **Local Settings** (⚙️) > **Image Settings** > **Display Settings** to enable the date and time display. Then you can view the date and time information in live view interface.

4 Temperature Measurement

Purpose:

The thermography (temperature measurement) function provides the real-time temperature of the scene and displays it on the left of your screen. The thermography function is turned on by default.

4.1 Set Thermography Parameters

Purpose:

The thermography parameters affect the accuracy of temperature measurement.

Steps:

1. Select **Local Settings** (⚙️) from the main menu.
2. Select **Thermography Settings**.

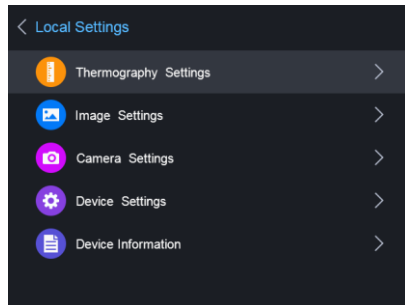

Set thermography range, emissivity, distance, background temperature, reflection temperature, humidity, and black body temperature calibration.

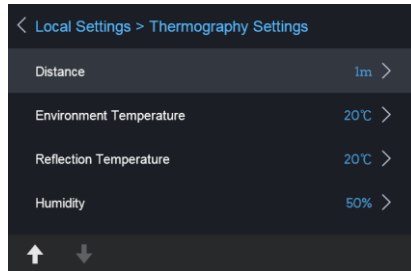

- Thermography Range

Select the thermography range. The device can detect the temperature and switch thermography range automatically in **Auto Switch** mode.

- Emissivity

Set the emissivity of your target as the effectiveness in emitting energy as thermal radiation.



Refer to the *9.1 Common Material Emissivity Reference* for Emissivity values.

Go to **Local Settings** (⚙️) > **Image Settings** > **Display Settings** to enable/disable the emissivity display.

- Distance

The straight-line distance between the target and the device. You can customize the target distance according to your needs.

- Background Temperature

The average temperature of the environment.

- Reflection Temperature

If any object (not the target) of high temperature is in the scene, and the target emissivity is low, set the reflection temperature as the high temperature to correct the thermography effect.

- Humidity

Set the relative humidity of current environment.

- Black Body Temperature Calibration

Use this function to improve temperature measurement accuracy.

3. Return to previous menu to save the settings.

4.1.1 Set Units

Go to **Local Settings > Device Settings > Unit Settings** to set the temperature unit and distance unit.



You can go to **Local Settings > Image Settings > Display Settings** to enable/disable the temperature unit display.

4.2 Set Temperature Difference/Range

Purpose:

Set a temperature section and the palette only works for targets within the temperature section. You can adjust the temperature range and set the temperature difference.

Steps:

1. Select **Range** (🔌) from the main menu.

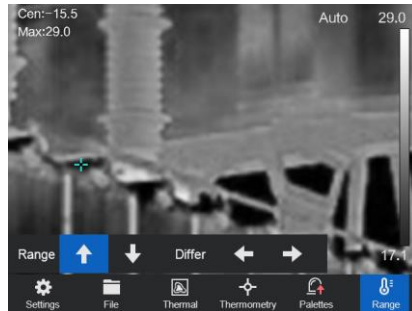

2. Select **Auto** (📊) adjustment or **Manual** (👉).

Auto Adjustment:

- 1) Select **Auto** (📊).
- 2) Press **OK** to confirm. The device adjusts temperature difference and temperature range parameters automatically.

Manual Adjustment:

- 1) Select **Manual** (👉).
 - 2) Press **OK** to confirm. The color-temperature bar displays.
 - 3) Press **▷** to enlarge the temperature section range (e.g. temperature range changes from **20 °C - 40 °C** to **19 °C - 41 °C**), or press **◁** to narrow the temperature range.
 - 4) Press **Δ** to move the temperature section higher (e.g. temperature range changes from **20 °C - 40 °C** to **30 °C - 50 °C**), or press **▽** to lower the temperature section.
3. Press (👈) to exit.

4.3 Set Thermography Rule

Purpose:

The thermography parameters affect the accuracy of temperature measurement.

Steps:

1. Select **Thermography Rule Configuration** (🔍) from the main menu.
2. Set the point, line, or frame rules. See figure below.

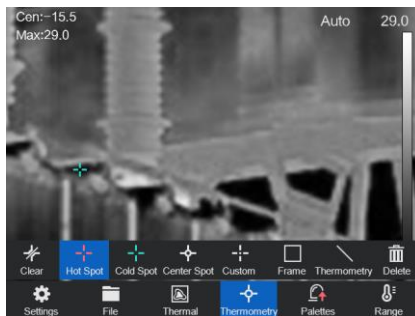

4.3.1 Set Point Rule

You can set Center Point Thermography, High-Temperature Point, Low-Temperature Point, and Custom Point Thermography.

- **Center Point Thermography**

System detects the temperature of the center.

Tap  and the temperature (center of view) displays **Cen: XX**.

- **High-Temperature Point** 

System locates the point of the highest temperature.

Tap  and the temperature (Highest temperature of view) displays **Max: XX**.

- **Low-Temperature Point**

System locates the point of the lowest temperature.

Tap  and the temperature (Lowest temperature of view) displays **Min: XX**.

- **Custom Point Thermography** 

System detects the temperature of a custom point.

Steps:

1. Choose  on the interface.
2. Press **OK**.
3. Move the point with the navigation buttons or tap on the touch-screen to select a point.
4. Press **OK** to confirm. The temperature of custom point (e.g. P1) displays **P1: XX**.
5. Repeat step 1 to 3 to set other custom points.



At most ten custom points supported.

4.3.2 Set Line Rule

Steps:



1. Choose  on the interface.
2. Press **OK** to generate a default line.
3. Press the Δ , ∇ , \triangleright , and \triangleleft to move the line up/down/left/right.
4. Drag points of the line on the touch-screen to extend or shorten the line.
5. Press **OK**. The Max. Temperature, Low Temperature, and Average Temperature of line (e.g. L1) displays **L1**
Max: XX Min: XX Avg: XX. The real-time temperature trend chart will display.



Only one line supported.

4.3.3 Set Frame Rule

Steps:

1. Choose  on the interface.
2. Press **OK** to generate a default frame.
3. Press the Δ , ∇ , \triangleright , and \triangleleft to move the frame up/down/right/left.
4. Press  to enlarge the frame, and press  to contract the frame. Or you can drag the corner of the frame on touchscreen to enlarge or contract the frame.
5. Press **OK**. The Max. Temperature, Low Temperature, and Average Temperature of frame (e.g. S1) displays **S1 Max: XX Min: XX Avg: XX**.
6. Repeat step 1 to 5 to set other frames.



At most three frames supported.

4.3.4 Delete Rules

Tap  and press **OK** to clear all temperature rules.

Or tap  and choose the single rule you want to delete to delete it.

4.4 Set Black Body Temperature Calibration



You need to purchase black body according to your need. Skip this step if the device is not equipped with black body.

If black body is installed around the device, setting the black body temperature calibration can improve the temperature measurement accuracy.

Go to **Settings > Local Settings > Thermography Settings > Black Body Temperature Calibration > Calibration Mode**. Both auto calibration and manual calibration are selectable. You can also turn this function off.

4.4.1 Auto Calibration

Steps:

1. Press the Δ and ∇ to select **Auto** and press **OK** to start auto calibration.

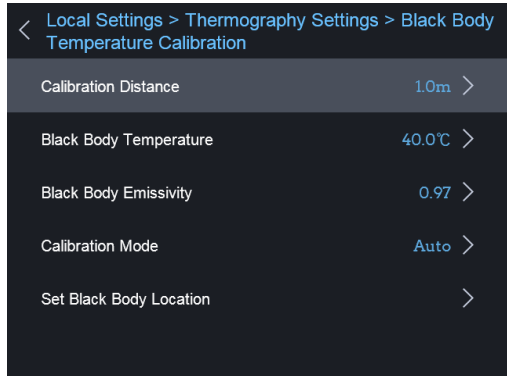

2. Press the Δ and ∇ or tap the screen to aim the calibration point at the black body.
3. Press **OK** to complete calibration.

4.4.2 Manual Calibration

Steps:

1. Press the Δ and ∇ to select **Manual** and press **OK** to start manual calibration.

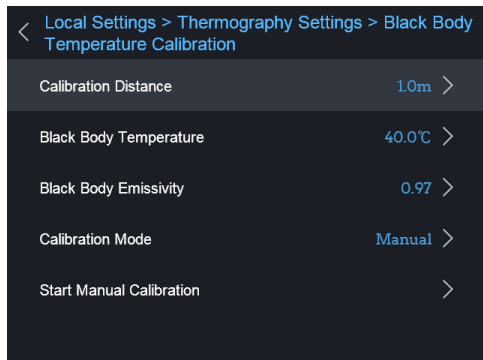

2. Aim the device at the black body and press **OK** to complete calibration.

4.5 Set Temperature Alarm

Before you start:

Go to **Palettes Settings** () to set the palette.

Purpose:



Set the alarm rules and the device will alarm when the temperature triggers the rule.

Steps:

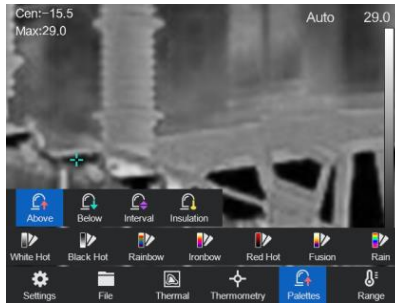
1. Go to **Palettes Settings** () from the main menu.



2. Tap on the icons to select an alarm rule type.
3. (Optional) Press the Δ and ∇ to select between upper limit and lower limit.
4. Press the \triangleleft and \triangleright to adjust the rule temperature.

Icon	Alarm Mode	Description
	Above Alarm	Set the alarm temperature, and the device alarms when target temperature is higher than rule temperature.
	Below Alarm	Set the alarm temperature, and the device alarms when target temperature is lower than rule temperature.
	Interval Alarm	Set the alarm temperature section (e.g., 90 °C to 150 °C), when target temperature is within the section (e.g., 100 °C), the

		device alarms.
	Insulation Alarm	Set the alarm temperature section (e.g., 90 °C to 120 °C), when target temperature is without the section (e.g., 70 °C or 125 °C), the device alarms.

5. Press  to exit.



Go to **Local Settings > Image Settings > Audible Warning**. Tap on  to enable audible warning. The device will sound when alarm is triggered.

5 Picture and Video

Before you start:

Insert memory card into the device, then you can record videos, capture snapshots, and mark and save important data.



- Device does not support capturing or recording when the menu is shown.
- When the device is connected to your PC, it does not support capturing or recording.
- Go to **Local Settings > Device Settings > Filename Header**. You can set the filename header for capturing or recording to distinguish the files recorded in a specify scene.

5.1 Capture Picture



You can set the **Flashlight Setting** ON/OFF if required.





Go to **Local Settings > Image > Picture Resolution** to set the resolution of optical image if required.

Steps:

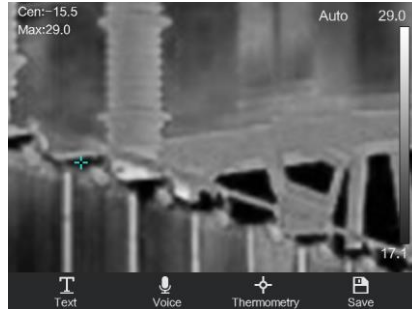
1. Select **Local Settings**  from the main menu.
2. Go to **Local Settings > Camera Settings > Trigger Settings**.
3. Select **Capture**.
4. Press **OK**.

5. Press  to exit.
6. In the live view interface, pull the trigger to capture snapshot.



7. The live view freezes and device displays the snapshot editing interface.
 - 1) Set text remark or voice remark.
 - Tap  to add text remarks. Tap the screen to show the keypad interface, enter the comment and confirm.
 - Tap  to add voice remarks. Hold **OK** to start recording and release the button to stop recording.
 - 2) Add thermography data.
 - Tap  to add thermography rules. Refer to 4.2 *Set Thermography Rule* for details.
 - 3) Tap  or pull the trigger to save the snapshot.

 **NOTE**

You can also press  to quit the saving.

8. Refer to 5.4 *Export File* to export the snapshots.

 **NOTE**

In the menu interface, you can pull the trigger to exit, and pull the trigger again to capture snapshot.

5.2 Record Video

Steps:

1. Select **Local Settings** (⚙️) from the main menu.
2. Go to **Local Settings > Camera Settings > Trigger Settings**.
3. Select **Record**.
4. Press **OK**.



You can set the **Flashlight Setting ON/OFF** if required.

5. Press (⏪) to exit.
6. In the live view interface, pull the trigger to start recording. The recording icon and count down number display in the interface.



7. When you finish, pull the trigger again to stop recording. The recording video will be saved automatically and exit.



You can also press **OK** or (⏪) to stop recording.

8. Refer to *5.4 Export File* to export the videos.



In the menu interface, you can pull the trigger to exit, and pull the trigger again to start recording.



5.3 View Recorded Files

Steps:

1. Select the **Files** (📁) from the main menu.

2. Press the Δ , ∇ , \triangleright , and \triangleleft to select the video or snapshot.
3. Press **OK** to view the file.



- When you are viewing the videos or capturing snapshots, you can switch the file by tapping  or .
- When you are viewing the snapshots, you can tap  to play the sound. Refer to 6 *Connect Bluetooth* to set the Bluetooth.
- For more information contained in capture snapshots or videos, you can install the thermography client to analyse them. You can get the thermography client software from the disk packed in box.

5.4 Export Files

Purpose:

Connect the device to your PC with supplied cable. You can export the recorded videos and captured snapshots.

Steps:

1. Open the cover of cable interface.
2. Connect the device to your PC with cable and open the detected disk.
3. View the videos and snapshots.
 - Select and copy the videos to PC and play the file with the player.
 - Select and copy the snapshots to PC and view the files.
4. Disconnect the device from your PC.



For the first time connection, the driver will be installed automatically.

6 Connect Bluetooth

Purpose:

After pairing the device with bluetooth headsets successfully, you can record and hear the sound contained in the videos or images via bluetooth headsets

Steps:

1. Select **Local Settings** (⚙️) from the main menu.
2. Go to **Local Settings > Device Settings > Bluetooth**.
3. Tap **Bluetooth** to enable the bluetooth function. The device will search the nearby enabled bluetooth headsets and pair them automatically.



You can also press or **OK** to quit pairing.

Result:

After pairing you can record and hear the sound via the headsets while recording and playing the video or image.

7 Hik-Thermal APP Connection

The device supports both Wi-Fi connection and WLAN hot spot. Connect the device to Hik-Thermal client software, and you can control the device via mobile client.

7.1 Connect via Wi-Fi

Before you start:

Download and install client software on your phone.

Steps:

1. Go to **Local Settings > Device Settings > Wi-Fi Settings**.
2. Tap on **Connect to Wi-Fi** to enable Wi-Fi, and the searched Wi-Fi will be listed below.
3. Select your Wi-Fi and enter password to show the keypad interface.



DO NOT tap **enter** or **space**, or the password may be incorrect.

4. Tap **Close** to hide the keypad.
5. Tap **OK**.

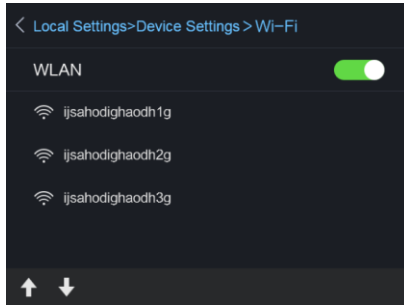

6. Launch the app and follow the startup wizard to create, and register an account.
7. Add the device to online devices.

Result:

You can view the live view, capture snapshots, and record videos via the client.

7.2 Connect via Hot Spot

Before you start:

Download and install client software on your phone.

Steps:

1. Go to **Local Settings > Device Settings > Wi-Fi Hotspot Settings**.
2. Tap on **Hot Spot** to enable the WLAN hot spot function.
3. Tap **Set Hot Spot** to set the WLAN hot spot. The hot spot name and password display automatically.
4. Edit the hot spot name and password, show the keypad interface.



DO NOT tap **enter** or **space**, and at least 8 characters, or the password may be incorrect.

5. Tap **Close** to hide the keypad.

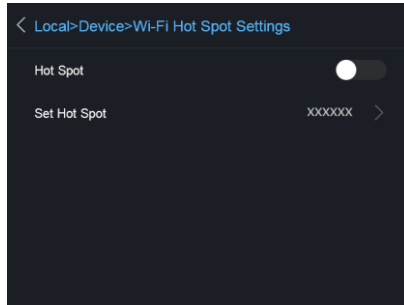

6. Connect your phone to the WLAN Hot Spot of the device.
7. Launch the app and follow the startup wizard to create, and register an account.
8. Select Wi-Fi configuration in the software, enter the serial number of device to add the device. Refer to the manual of client software for details

Result:

You can view the live view, capture snapshots, and record videos via the client.

8 Maintenance

8.1 View Device Information

Go to **Local Settings** (⚙️) > **Device Information** to view the device information: Model, Version No., FPGA Version No., Serial No., IP address, and so on.

8.2 Upgrade Device

Steps:

1. Connect the device to your PC with cable and open the detected disk.
2. Copy the upgrade file and paste it to the root directory of the device.
3. Disconnect the device from your PC.

4. Reboot the device and then it will upgrade automatically. The upgrading process will be displayed in the main interface.



After the upgrading, the device automatically reboots. You can view the current version in **Local Settings** (⚙️) > **Device Information**.

8.3 Restore Device

Go to **Local Settings** (⚙️) > **Device Settings** > **Device Initialize** to initialize the device and restore default settings.

9 Appendix

9.1 Common Material Emissivity Reference

Material	Emissivity
Human Skin	0.98
PCB	0.91
Cement Concrete	0.95
Ceramics	0.92
Rubber	0.95
Paint	0.93
Wood	0.85
Asphalt	0.96
Brick	0.95
Sand	0.90
Soil	0.92
Cotton	0.98
Cardboard	0.90
White Paper	0.90
Water	0.96

9.2 Device Command

Scan the following QR code to get device common serial port commands.

Note that the command list contains the commonly used serial port commands for Hikvision thermal cameras.



9.3 Device Communication Matrix

Scan the following QR code to get device communication matrix.

Note that the matrix contains all communication ports of Hikvision thermal cameras.



9.4 Frequently Asked Questions (FAQ)

Q: Why is the charge indicator flashing red?

A: Examine the items below.

1. Examine whether the device is charged with the standard power adapter.
2. Plug and unplug the battery once.
3. Make sure the charging temperature is above 0 °C (32 °F).

Q: Device image is fuzzy. How to adjust it?

A: Refer to *Focus Lens* to adjust the focus knob clockwise or anticlockwise.

Q: Why cannot the Wi-Fi be found?

A: Examine whether the Wi-Fi function is turned on. If not, refer to *7.1 Connect via Wi-Fi* to turn on Wi-Fi.

Q: Capturing or recording fails. How to operate?

A: Examine the items below:

1. Whether the device is connected to your PC and disabled the capturing and recording.
2. Whether the storage space is full.
3. Whether the device is low-battery.

Q: Why cannot the PC recognize the device?

A: Examine whether the device is connected to your PC with standard cable.



See Far, Go Further