

Multiline Display Keypad **MDK-C6**

Installation Manual

SAFETY INSTRUCTIONS

For your safety, please read and follow these precautions before installing or using this product:

1. Read instructions. Read and understand all the applicable instructions before installing or operating the product.
2. Retain instructions. Keep this manual in a convenient place for reference.
3. Heed warnings. Be aware and heed all warnings on the product and in the instructions.
4. Follow instructions. Install and use this product only as described in the instructions. Don't try to use this product in ways for which it wasn't designed.
5. Use indoors only. Don't expose this product to the weather or harsh environmental conditions such as continuous sunlight, excessive humidity, or rain.
6. Keep product dry. Don't use the product near water; for example, near a bathtub, washbowl, kitchen sink, laundry tub, in a wet basement, or near a swimming pool. Also, do not handle the product when your hands are wet or damp.
7. Use the right power source. Don't connect the product directly to electrical line voltage. Use only the power adapter provided with the product, described in the operating instructions, or as marked on the product.
8. Ground product properly. Make sure the product's means of grounding or polarization is not defeated.
9. Power cord protection. Power supply cords should be routed so that they are not likely to be walked on or pinched by items placed upon or against them, paying particular attention to cords at plugs, receptacles, and the point where they exit from the appliance.
10. Keep product clean. From time to time, wipe off the product with a clean soft cloth. Don't use abrasive materials, thinners, alcohol or other chemical solvents or materials.
11. Avoid spills and foreign objects. Make sure liquids and objects don't get into the product enclosure through any openings.
12. Get professional service. Have the product serviced only by qualified service personnel when:
 - The power supply cord/plug has been damaged
 - Liquids spilled/objects have fallen into the product
 - The product has been exposed to rain
 - The product doesn't appear to operate normally
 - The product is damaged
13. Don't attempt to service the product yourself. Doing so will void the warranty.

If you have any questions, call Russound at 1.800.638.8055 or 603.659.5170.



Note: This equipment has been tested and found to comply with the limits for a Class B digital device, pursuant to part 15 of the FCC rules. These limits are designed to provide reasonable protection against harmful interference in a residential installation. This equipment generates, uses and can radiate radio frequency energy and, if not installed and used in accordance with the instructions, may cause harmful interference to radio communications. However, there is no guarantee that interference will not occur in a particular installation. If this equipment does cause harmful interference to radio or television reception, which can be determined by turning the equipment off and on, the user is encouraged to try to correct the interference by one of or more of the following measures: reorient or relocate the receiving antenna; increase the separation between the equipment and receiver; connect the equipment into an outlet on a circuit different from that to which the receiver is connected, or consult the dealer or an experienced radio/TV technician for help.

This Class B digital apparatus complies with Canadian ICES-003.

Cet appareil numérique de la classe B est conforme à la norme NMB-003 du Canada.

Table of Contents

Product Information	
Safety.....	2
Product Overview.....	3
User Information	
Keypad Front View.....	4
Using the system.....	5
Keypad Installation	
Keypad Rear View.....	8
Color Conversion.....	9
External IR Connection.....	10
Keypad Installation.....	11
Controller / Keypad Connection.....	12
Specifications / Warranty	
Technical specifications.....	13
Warranty.....	13
Quick References - User Guide.....	14-15

Overview

The MDK-C6 keypad is a beautiful wall-mounted interface for C-Series controllers. It features a gray scale screen, menus and navigation buttons to easily find and control music sources and to make changes to system settings and room audio levels. The alarm and sleep timer add extra functionality.

This double-gang keypad offers responsive hard buttons to access power on/off, music pause, volume up/down, and menu shortcuts. The OK button in the center activates a menu choice and the navigation buttons allow you to move through menus and lists, as well as provide source controls. The buttons' LED brightness is adjustable and can be dimmed at the owner's discretion. It also supports IR reception for use with a remote control.

The gray scale LCD screen displays real-time information such as Playlist, Channel, Station, Artist, Song Title, Genre, and more from the audio sources.

The MDK-C6 is designed to control a C-Series system such as the MCA-C5 controller amplifier multiroom audio system. It controls Russound source equipment, including the DMS-3.1 Digital Media Streamer, iBridge™ Dock and ST1 Smart Tuner.

Most controller and source setup functions are performed through SCS-C5 programming software; however, a few installation steps are completed through the MDK-C6 menus, including setting time and date, keypad brightness and contrast, and adjusting room audio properties. The MDK-C6's installation screen provides a gateway for online support for the system when needed.

KEYPAD FRONT

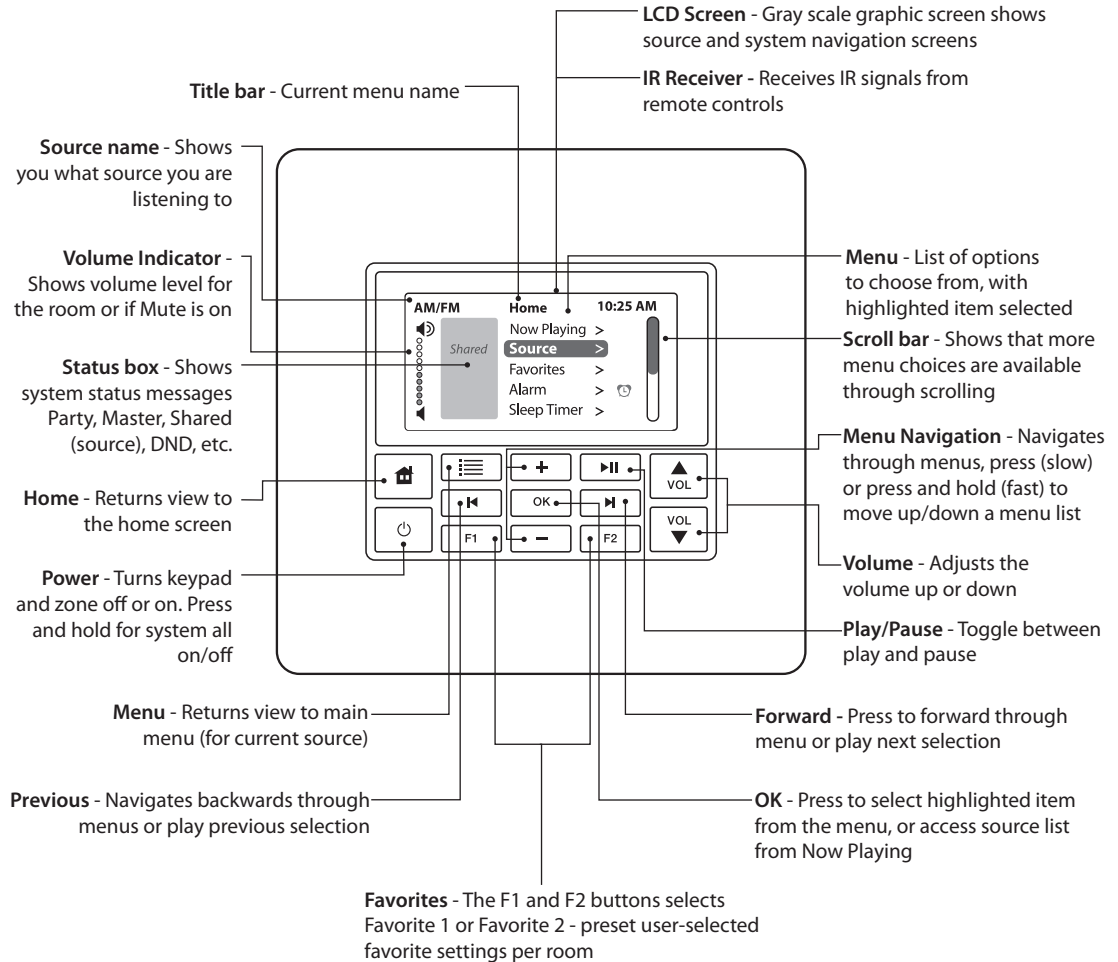

Basic Operation

Turn on the zone - Press the power button on the keypad or press power on the SRC-C5 remote control to turn on the zone and hear music. The zone will default to the last playing source before being turned off. Press and hold the power button (when ON) to turn on all enabled keypads.

Turn off the zone - Press the power button on the keypad or press the power button on the SRC-C5 remote control to turn off the keypad and music. Press and hold the power button (when OFF) to turn off all keypads.

Volume adjustments - Press the Volume up/down buttons on the side of the keypad, or press the VOL +/- button on the SRC-C5 remote control.

Mute Audio - Press the Mute button on the SRC-C5 remote control.

Main Menu - Sources

From the home screen, select "Sources." A list of available audio sources appears. Select a source, or press a numbered "Source" button on the SRC-C5 remote control.

Once selected, choose music from that source. Each source has its own menu and screens. Main menus list what is available: channels, genres, playlists, songs, or artists.

Shared - When you see "Shared" on the screen, what you are listening to is also playing in another room. If you change the selection (song, channel, playlist) *on that source*, the change will also happen in the other "Shared" room.

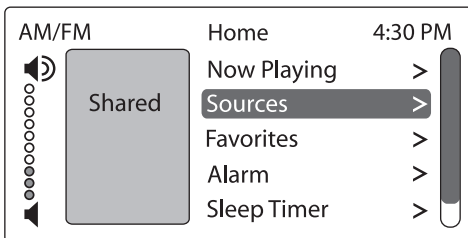

Main Menu - Global Favorites

Favorites - Save a source or a radio station/channel as a favorite.

Add new - Tune to the music source you want to save as a favorite. From the Favorites menu, select "Add New." Name the favorite using the +/- buttons to move through the alphabet. Press the OK button to save.

Edit name - Choose the favorite to rename and use the +/- buttons to scroll through the alphabet and the forward button to move to the next character.

Delete favorite - Choose the favorite to be deleted, press the OK button to delete.

F1 and F2 buttons - In addition to the 32 Global Favorites, the MDK-C6 features 2 zone specific presets.

These presets can be selected at any time to recall source selection, volume, favorite channel, disc, etc. To store an F1 or F2 favorite preset: first, adjust the room settings and select a source to be stored.

Press and hold the desired F1 or F2 button until "F1 SAVED" or "F2 SAVED" is displayed on the LCD panel. Now a press and release of the button will recall the favorite preset. To set a favorite numbered disc or channel, use + or - to select a disc or channel (e.g., channel 45). Wait for the keypad to show the source name, then press and hold the F1 or F2 within 15 seconds of setting the numeric selection to save the setting.

F1 and F2 buttons on MDK-C6 correspond with F1 and F2 buttons on the SRC-C5 Remote Control.

USING THE SYSTEM

Main Menu - Alarm

Set the keypad as an alarm clock and wake up to music. From the home screen menu, scroll to and select "Alarm" for the following options:

Alarm on/off - Activates alarm on or off. If an alarm is set a clock icon will appear on the keypad display.

Wake time - Set the time for the alarm to go off.

Wake to - Choose the music source.

Choose days - Set the alarm to go off on weekdays, all days or just once.

Set snooze - Choose the interval (5 to 30 minutes) before the alarm goes off again.

Alarm level - Set the volume of the alarm.

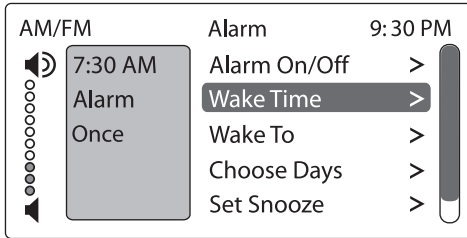

How to:

Turn off active alarm - Press the power button on the keypad or SRC-C5 remote.

Snooze - Press the play/pause button on the keypad or the pause button on the SRC-C5 remote control.

Main Menu - Sleep Timer

You can set the timer so the zone turns off in one of the following increments: 15, 30, 45, or 60 minutes.

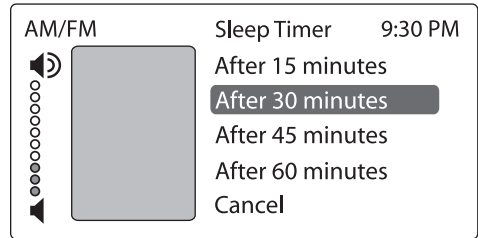

Main Menu - Set Party Mode or DND

Party and Master - The keypad that shows Master has started a "party" and keypads that show Party are "attending." All rooms are listening to the same music, and only the Master can change the music. Volume control remains independent.

DND - Stands for Do Not Disturb. Someone in another room has chosen a source and locked out anyone else from changing it. That room also won't be disturbed by paging or a doorbell chime.

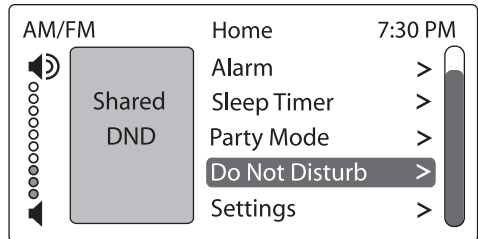

Main Menu - Settings

Audio

Adjust Settings - From the home screen, scroll to and select "settings," and choose "audio settings." You'll see items to adjust, such as bass, treble and balance. Each selection has its own screen and shows levels for real-time adjustments.

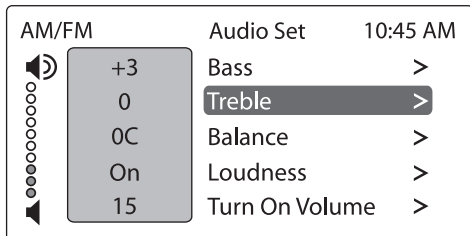

Clock

Set Time - From the Clock menu, select "Set Time." Press the +/- buttons to move through numbers. Press the |< or >| buttons to move the cursor and press OK to save.

Set Date - From the Clock menu, select "Set Date." The date format is month/day/year. Press the +/- buttons to move through numbers. Press the |< or >| buttons to move the cursor, and press OK to save.

Clock Format - From the home menu, select "Settings," then "Clock." Choose "Clock Format," and select 12 hour (AM/PM) or 24 hour (1200) format.

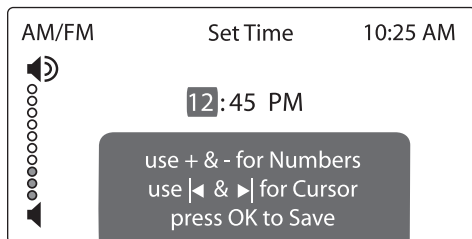

Display

Adjust Settings - Set the contrast and brightness for the keypad display. Use the buttons to move the cursor to the desired level.

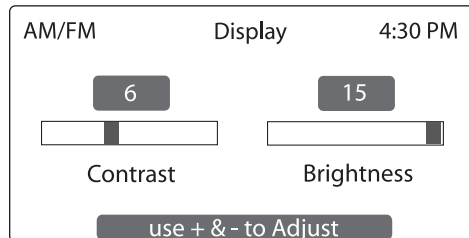

Installer Options

IR Enable/Disable - The default is Enabled. If an external IR receiver is used, the keypad IR receiver should be disabled. From the main menu, select "Settings", then "Installation", then IR Enable/Disable. Select "disable" and exit back to the menu.

Diagnostics - Select Display Test and Version list. Version shows firmware versions for controller and keypad, and keypad bootloader version.

Network Settings - If the MCA-C5 is connected to a network, its IP and MAC addresses can be read from the keypad. From the Home screen, choose "Settings", then "Installation." From the Installation menu, choose "Network Settings" to see the controller's IP address and MAC address.

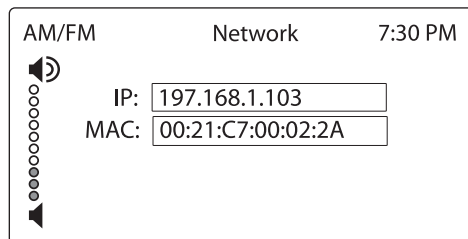

KEYPAD REAR

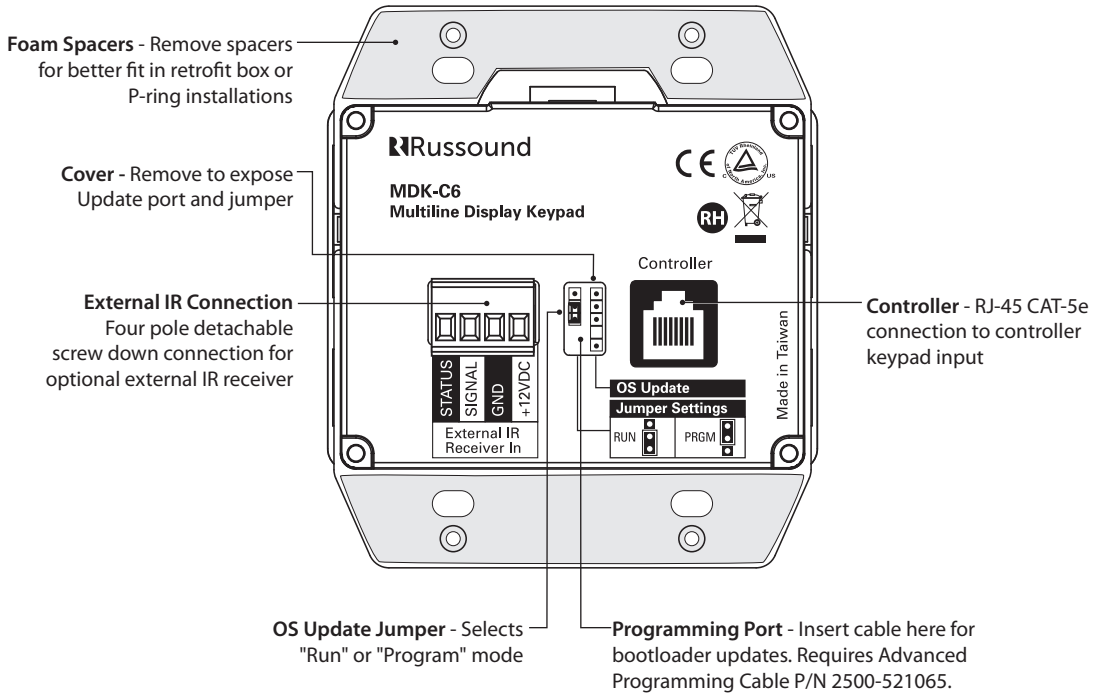

MDK-C6 Keypad (rear)

MDK-C6 Color Plate Conversion

You will need both small straight and Phillips head screwdrivers to change the color plates on the keypad. The Bezel Molding, Buttons and the Trim Plate will be switched for the new color plates.

1. If installed, remove the MDK-C6 keypad from the wall. Gently pull the Trim Plate off the mounting plate. Unscrew the unit from the electrical box, and disconnect the cable.
2. Unscrew the plastic Frame Plate. Keep the Frame Plate and screws for reattachment later.
3. Remove the Bezel Molding by gently pressing in each of the 4 locking tabs (2 per side) while pushing it away from the metal frame. CAUTION: To avoid damage to the LCD panel, do not use hard edged tools.
4. Remove the Display Lens from the Bezel Molding by gently pushing from the rear to overcome the clips.
5. Once the Display Lens is removed, put aside for reattachment later. Be careful to not damage the display.

6. Remove individual button caps by pulling them off the key mat.

7. Reverse the order for installation, taking the following precautions:

- a. Place button caps correctly on the key mat. Make sure the key mat is positioned properly on the circuit board and without dust or debris on the button contact points prior to attaching the Bezel Molding.
- b. Make sure that there isn't any debris or fingerprints on either the display or back of the Display Lens prior to reattachment.
- c. Use a clean, dry, lint-free soft cloth to gently wipe the display or back of the Display Lens to clean if necessary. Never use cleaning agents as this can cause streaking or permanent damage to either part.

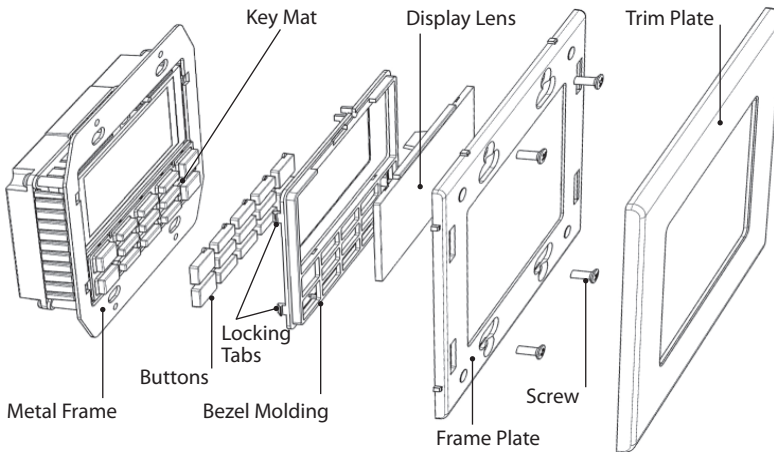

Keypad Disassembly / Assembly

Note:

Place individual buttons on key mat matching the diagram below.

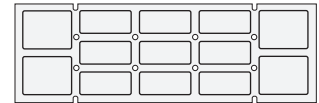

Key Mat

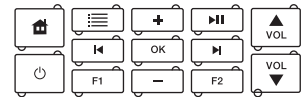

Individual Buttons

EXTERNAL IR CONNECTION

External IR Connection to MDK-C6 Keypad

The MDK-C6 keypad has an External IR Receiver In terminal for connecting an external IR Receiver such as the Russound 858, SaphIR 862 Eye, or SaphIR 860 Phantom.

Use 2 twisted pair wire with one pair connecting GND (GROUND) and IR (SIGNAL) and the other pair connecting ST (STATUS) and V+ (+12VDC). Do not connect the shield to the IR receiver terminals.

If utilizing an external IR receiver, then you must disable the IR receiver in the keypad. This is disabled in the installer options menu on the keypad. See screen at right.

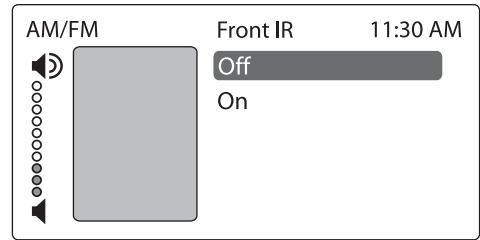

Disable Keypad IR

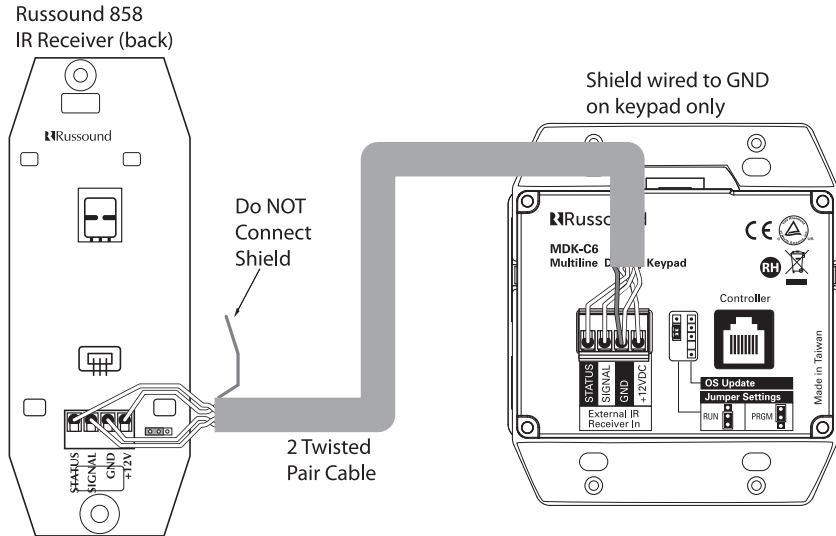

Connection of External IR to Keypad

Keypad Installation

For best viewing and usage, the MDK-C6 should be mounted at thermostat height, or about 58"-60" (1.5m) from the floor.

To install a double-gang keypad, you will need a UL/CSA approved plastic 32ci double-gang wall box. Attach the box to the wall with appropriate fasteners.

For installations employing a retrofit box or P-ring, the two foam spacers on the rear of the keypad's metal back plate can be removed for a better fit.

Route CAT-5e cable to the wall box from the controller. There should be not more than 250 feet of CAT-5e cable between the keypad and the controller.

Terminate the CAT-5e cable with an RJ-45 connector, using the T568A wiring standard. Insert the RJ-45 connector into the jack marked "Controller" on the back of the keypad.

Mount the keypad in the wall box and attach the cover plate. Repeat the steps until all keypads are installed.

RJ-45 CAT-5 Wiring Scheme

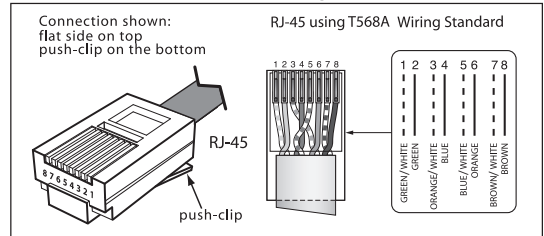

CAUTION

Mounting screws must be hand-tightened. Over-tightening the mounting screws can cause the buttons to jam and malfunction.

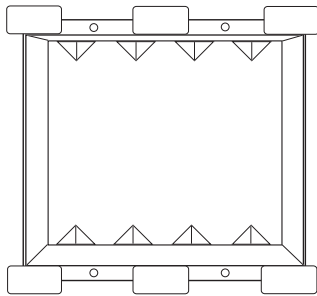
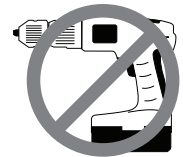

Double-gang wall box

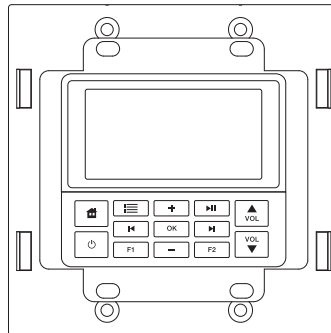

MDK-C6 keypad

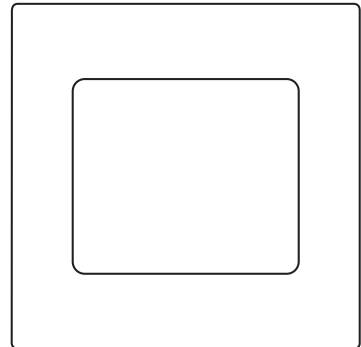

Cover plate

CONTROLLER / KEYPAD CONNECTION

Controller / Keypad Connection

The MDK-C6 keypad is designed for use with the C-Series controllers, and connects to a keypad port near the top left on the rear of the controller. These RJ-45 ports support MDK-C6 keypads (and up to eight TS3 touchscreens per controller).

The eight keypad ports correspond to the eight zones supported by the MCA-C5. When a connected keypad is powered on, the zone becomes active and the corresponding zone LED lights up on the front of the MCA-C5 controller.

Connections are made using CAT-5e with RJ-45 connectors using T568A wire configuration. For a clean installation when wiring from a keypad port use a CAT-5e patch cable to connect from the keypad port to a RJ-45 wall plate (optional). Using the same T568A RJ-45 wiring configuration, use CAT-5e from the wall plate to the keypad. Maximum CAT-5e cable length is 250 feet between the controller and the keypad. The OS Update jumper should be in the RUN position on the lower two pins.

If more keypads are desired for a zone, use an optional SA-ZX3 keypad splitter with a Russound 1201A (12VDC1A) power supply at the controller end. All keypads on an SA-ZX3 control the same zone. More detailed information regarding SA-ZX3 installation and operation can be found in its installation manual.

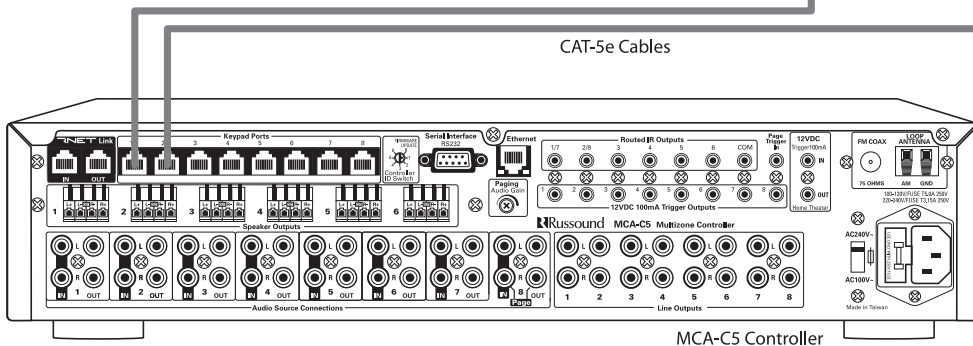
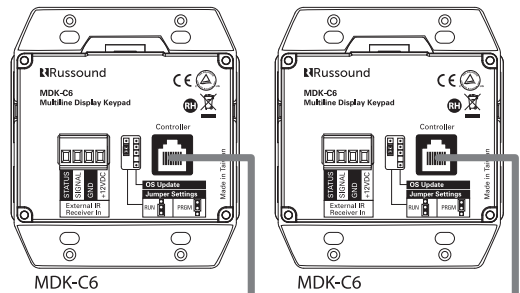

Keypad connection to the MCA-C5

MDK-C6 Keypad

Power requirements: 275mA @ 12VDC MAX

CAT-5e connection: RJ-45 (T568A standard)

Display: 70 mm W x 35 mm H
high resolution LCD

Controls: Thirteen backlit
hard buttons

Wall surface dimensions: 4.5"W x 4.5"H
(11.43 x 11.43 cm)

Inside box dimensions: 3.5"W x 1.5"D x 2.75"H
(8.9 x 3.8 x 6.9 cm)

Weight: 1 lbs. (0.45 kg)

WARRANTY

The Russound MDK-C6 Multiline Display Keypad is fully guaranteed against all defects in materials and workmanship for two (2) years from the date of purchase. During this period, Russound will replace any defective parts and correct any defect in workmanship without charge for either parts or labor.

For this warranty to apply, the unit must be installed and used according to its written instructions. If service is necessary, it must be performed by Russound. The unit must be returned to Russound at the owner's expense and with prior written permission. Accidental damage and shipping damage are not considered defects, nor is damage resulting from abuse or from servicing by an agency or person not specifically authorized in writing by Russound.

This Warranty does not cover:

- Damage caused by abuse, accident, misuse, negligence, or improper installation or operation
- Power surges and lightning strikes
- Normal wear and maintenance

- Products that have been altered or modified
- Any product whose identifying number, decal, serial number, etc. has been altered, defaced or removed.

Russound sells products only through authorized Dealers and Distributors to ensure that customers obtain proper support and service. Any Russound product purchased from an unauthorized dealer or other source, including retailers, mail order sellers and online sellers will not be honored or serviced under existing Russound warranty policy. Any sale of products by an unauthorized source or other manner not authorized by Russound shall void the warranty on the applicable product.

Damage to or destruction of components due to application of excessive power voids the warranty on those parts. In these cases, repairs will be made on the basis of the retail value of the parts and labor. To return for repairs, the unit must be shipped to Russound at the owner's expense, along with a note explaining the nature of service required. Be sure to pack the unit in a corrugated container with at least three (3) inches of resilient material to protect the unit from damage in transit.

Before returning a unit for repair, call Russound at (603) 659-5170 for a Return Authorization number. Write this number on the shipping label and ship to:

Russound
ATTN: Service
5 Forbes Road
Newmarket, NH 03857

Due to continual efforts to improve product quality as new technology and techniques become available, Russound/FMP, Inc. reserves the right to revise system specifications without notice.

QUICK REFERENCES - USER GUIDE

How do I?

Turn on the keypad

Press the power button to turn on the keypad and hear music. Press and hold the power button (when ON) to turn on all enabled zones. OR press Power on the SRC-C5 remote control.

Turn off the keypad

Press the power button to turn off the keypad and the music. Press and hold the power button (when OFF) to turn off all the keypads. OR press Power on the SRC-C5 remote control.

Choose music or video source

From the Home screen, scroll to and select "Sources." A list of available music sources appears. Scroll to and select a music source. OR use the numbered buttons under "Source" on the SRC-C5 remote control.

Play music or video

Each type of music or video source has its own menus and screens that list what is available to choose from, such as channels, genres, playlists, songs or artists.

Create presets

You can save presets for Russound tuner stations/channels. Select the tuner as the source, and tune to the desired station. From the tuner menu, choose a bank (1-6). Scroll to a preset, then press and hold the Select button to save.

Adjust the room's sound

From the Home screen, scroll to and select "Settings," and choose "Audio Settings." You'll see items to adjust, such as bass, treble and balance. Each selection has its own screen and shows levels for real-time adjustments.

For volume adjustments, press the Volume up/down buttons on the side of the keypad. OR press the VOL +/- button on the SRC-C5 remote control.

To mute the room's audio, press the Mute button on the SRC-C5.

What do these mean?

Shared

When you see "Shared" on the screen, what you are watching or listening to is also playing in another room.

DND

Stands for Do Not Disturb. Someone in another room has chosen a source and locked out anyone else from changing it. That room also won't be disturbed by paging or doorbell chime. To enable DND, choose DND from the Home screen and select On. To disable, select Off.

Party and Master

The keypad that shows Master has started a "party" and keypads that show Party are "attending." All rooms are listening to the same music, and only the Master can change the music.

Using Party and Master

From the Home screen, choose Party Mode. Choose Master; now this keypad is in charge and all enabled zones will turn on. When the Master keypad turns Party Mode off, all zones turn off. You can transfer Master to another zone by choosing Master from that zone's keypad.

Favorites

You can save a source or a radio station/channel as a favorite. The Favorites menu is reached from the Home screen.

Managing favorites

Tune to the music source you want to save as a favorite. From the Favorites menu, select Add new. Name the favorite using the wheel to move through the alphabet. When named, press the select button to save.

Edit name

From the Favorites menu, choose Edit Name. Choose the favorite to rename from the list and use the wheel to scroll

through the alphabet and the forward button to move to the next character.

Delete favorite

From the Favorites menu, select Delete Favorite. Scroll to the favorite to be deleted, and press the select button to delete.

Alarm

You can set the keypad as an alarm clock and wake up to a buzzer or music. Start at the Home screen menu, then scroll to and select "Alarm" for the following options.

Managing alarm

Activates alarm on or off.

Wake time

Set the time you want the alarm to go off.

Wake to

Choose the sound to wake you, the alarm buzzer, a music source or a programmed favorite.

Choose days

Set the alarm to go off on weekdays, all days or just once.

Set snooze

Choose to catch an extra 5 to 30 minutes before the alarm goes off again.

Alarm level

Set the volume of the sound to wake you.

To turn off active alarm

Press the power button on the keypad or SRC-C5 remote.

To snooze

Press the pause button on the keypad or the SRC-C5 remote.



Multiline Display Keypad **MDK-C6**

Installation Manual

©2012 Russound. All rights reserved.
All trademarks are the property of their respective owners. Specifications are subject to change without notice. Russound is not responsible for typographical errors or omissions.

Russound, Inc.
5 Forbes Road, Newmarket, NH 03857
tel 603.659.5170 • fax 603.659.5388
email: tech@russound.com www.russound.com

28-1374 08/24/12